

Hot Water Storage Tanks

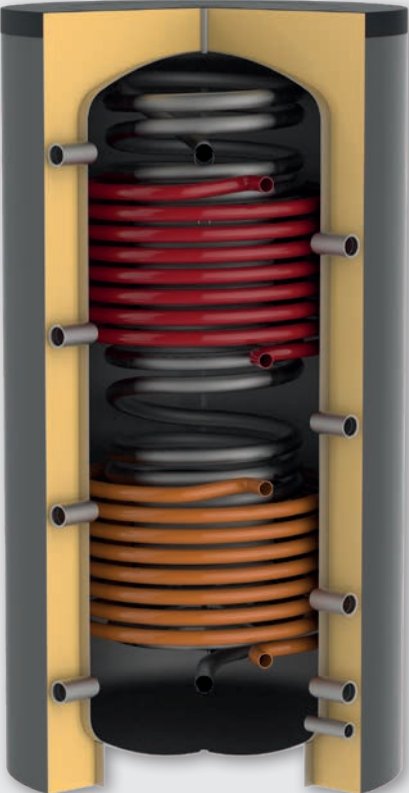

infini

PUFFER

Hot Water storage tanks

The Puffer tanks are inertial tanks for heating installations which store non-domestic hot water. They are used in all devices powered by discontinuous power sources (e.g. solar panels, wood burners, boiler stoves, etc.) or wherever the volume of water stored in the device must be increased (e.g. devices with heat pumps, combined heat and power units, biomass burners, etc.). Several versions are available, to be used with one or more energy sources:

PFA Regular storage tank

PFB Storage tank fitted with smooth tube heat exchanger to add an additional power source (e.g. solar).

PFC Storage tank fitted with two smooth tube heat exchangers to add two additional power sources (e.g. solar and boiler stove).

Materials

All storage tanks are made of carbon steel sheets, externally varnished

Insulation

Capacity (l)	Type
from 300 to 1000	Highly rigid polyurethane foam
from 1500 to 5000	Polyester Fiber
from 6000	Flexible polyurethane foam

Operational limits

Model	Storage tank		S1 Coil Circuit		S2 Coil Circuit	
	max. temperature	max. pressure	max. temperature	max. pressure	max. temperature	max. pressure
PFA	95°C	6 bar	-	-	-	-
PFB	95°C	6 bar	99°C	9 bar	-	-
PFC	95°C	6 bar	99°C	9 bar	99°C	9 bar



 **Standard Accessories:** see pag 274

 **Special versions:** see pag 277

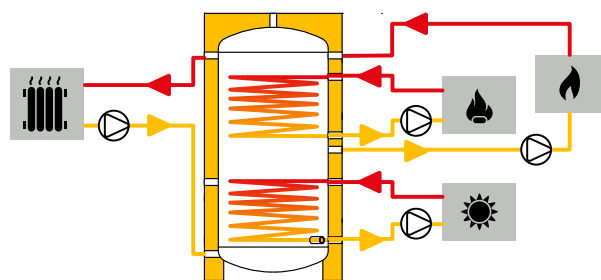

PUFFER

Product code

PFA series

capacity l	code	price	energy label	packed	
				dimensions cm	weight kg
300	817010119X	€ 748,00	B	64x64x180	55
500	817010120X	€ 960,00	C	77x77x184	77
750	817010216X	€ 1.313,00	C	95x95x178	117,5
1000	817010002	€ 1.515,00	C	129x129x216	125
1500	817010003	€ 1.919,00	C	125x125x229	194
2000	817010004	€ 2.323,00	C	136x136x261	263
2500	817010101X	€ 2.677,00		147x147x234	296
3000	817010102X	€ 2.909,00		147x147x284	346
4000	817010103X	€ 3.805,00		163x163x293	492
5000	817010104X	€ 4.469,00		183x183x299	582
6000	817010129X	€ 5.909,00		282x203x217,5	684
8000	817010130X	€ 7.171,00		352x203x217,5	823
10000	817010131X	€ 8.383,00		427x203x217,5	973

PFB series

capacity l	code	price	energy label	packed	
				dimensions cm	weight kg
300	819010129X	€ 928,00	B	64x64x180	65
500	819010130X	€ 1.172,00	C	77x77x184	98
750	819010202X	€ 1.586,00	C	95x95x178	144,5
1000	819010003	€ 1.844,00	C	129x129x216	153
1500	819010004	€ 2.374,00	C	125x125x229	237
2000	819010005	€ 2.828,00	C	136x136x261	315
2500	819010135X	€ 3.270,00		147x147x234	352
3000	819010136X	€ 3.699,00		147x147x284	413
4000	819010137X	€ 4.695,00		163x163x293	571
5000	819010138X	€ 5.404,00		183x183x299	672

PFC series

capacity l	code	price	energy label	packed	
				dimensions cm	weight kg
300	819010149X	€ 1.133,00	B	64x64x180	77
500	819010150X	€ 1.445,00	C	77x77x184	111
750	819010203X	€ 1.869,00	C	95x95x178	162,5
1000	819010006	€ 2.177,00	C	129x129x216	181
1500	819010007	€ 2.778,00	C	125x125x229	268
2000	819010008	€ 3.384,00	C	136x136x261	346
2500	819010155X	€ 3.829,00		147x147x234	383
3000	819010156X	€ 4.353,00		147x147x284	460
4000	819010157X	€ 5.616,00		163x163x293	628
5000	819010158X	€ 6.356,00		183x183x299	730

PUFFER Size PFA

300 ≤ cap. ≤ 1.000

1.500 ≤ cap. ≤ 5.000

6.00 ≤ cap. ≤ 10.000

Couplings legend

- E1** Probe / Thermometer
- E2** Probe / Thermometer
- E3** Probe / Thermometer
- E4** Probe / Thermometer
- G1** From plant
- G2** To plant
- I** Electrical resistor
- K1** Auxiliary
- K2** Auxiliary
- K3** Auxiliary
- K4** Auxiliary
- P1** To energy source
- P2** From energy source
- T** Vent

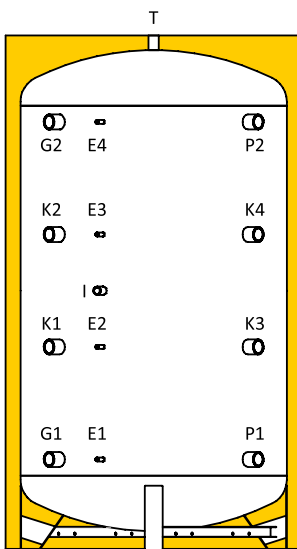
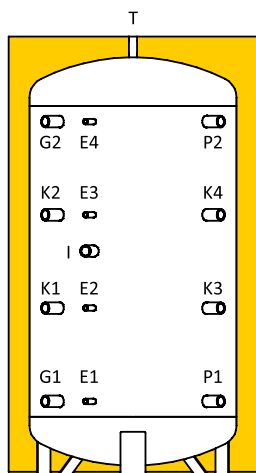
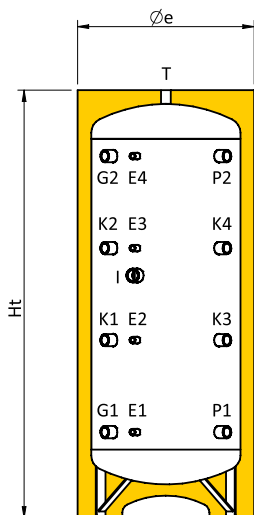

Couplings chart

Cap. l	E1 inch	E2 inch	E3 inch	E4 inch	G1 inch	G2 inch	I inch	K1 inch	K2 inch	K3 inch	K4 inch	P1 inch	P2 inch	T inch
300	1/2"	1/2"	1/2"	1/2"	1 1/4	1 1/4	1 1/2	1 1/4	1 1/4	1 1/4	1 1/4	1 1/4	1 1/4	1 1/4
500	1/2"	1/2"	1/2"	1/2"	1 1/4	1 1/4	1 1/2	1 1/4	1 1/4	1 1/4	1 1/4	1 1/4	1 1/4	1 1/4
750	1/2"	1/2"	1/2"	1/2"	1 1/2	1 1/2	1 1/2	1 1/2	1 1/2	1 1/2	1 1/2	1 1/2	1 1/2	1 1/2
1000	1/2"	1/2"	1/2"	1/2"	1 1/2	1 1/2	1 1/2	1 1/2	1 1/2	1 1/2	1 1/2	1 1/2	1 1/2	1 1/2
1500	1/2"	1/2"	1/2"	1/2"	1 1/2	1 1/2	1 1/2	1 1/2	1 1/2	1 1/2	1 1/2	1 1/2	1 1/2	1"
2000	1/2"	1/2"	1/2"	1/2"	1 1/2	1 1/2	1 1/2	1 1/2	1 1/2	1 1/2	1 1/2	1 1/2	1 1/2	1"
2500	1/2"	1/2"	1/2"	1/2"	2"	2"	1 1/2	2"	2"	2"	2"	2"	2"	1"
3000	1/2"	1/2"	1/2"	1/2"	2"	2"	1 1/2	2"	2"	2"	2"	2"	2"	1"
4000	1/2"	1/2"	1/2"	1/2"	2"	2"	1 1/2	2"	2"	2"	2"	2"	2"	1"
5000	1/2"	1/2"	1/2"	1/2"	2"	2"	1 1/2	2"	2"	2"	2"	2"	2"	1"
6000	1/2"	1/2"	1/2"	1/2"	3"	3"	1 1/2	3"	3"	3"	3"	3"	3"	2"
8000	1/2"	1/2"	1/2"	1/2"	3"	3"	1 1/2	3"	3"	3"	3"	3"	3"	2"
10000	1/2"	1/2"	1/2"	1/2"	3"	3"	1 1/2	3"	3"	3"	3"	3"	3"	2"

Size chart

Cap. l	Øe mm	Ht mm	R* mm	E1 mm	E2 mm	E3 mm	E4 mm	G1 mm	G2 mm	I mm	K1 mm	K2 mm	K3 mm	K4 mm	P1 mm	P2 mm
300	610	1680	1790	325	695	1065	1435	325	1435	880	695	1065	695	1065	325	1435
500	760	1735	1895	355	725	1095	1465	355	1465	985	725	1095	725	1095	355	1465
750	910	1765	1990	395	745	1095	1445	395	1445	920	745	1095	745	1095	395	1445
1000	1010	2000	2245	330	770	1210	1650	330	1650	990	770	1210	770	1210	330	1650
1500	1250	2145	2475	360	810	1260	1710	360	1710	1085	810	1260	810	1260	360	1710
2000	1350	2475	2815	390	930	1470	2010	390	2010	1200	930	1470	930	1470	390	2010
2500	1450	2220	2655	425	865	1305	1745	425	1745	1145	865	1305	865	1305	425	1745
3000	1450	2720	3085	435	1035	1635	2235	435	2235	1435	1035	1635	1035	1635	435	2235
4000	1600	2810	3235	480	1080	1680	2280	480	2280	1430	1080	1680	1080	1680	480	2280
5000	1800	2870	3390	510	1110	1710	2310	510	2310	1510	1110	1710	1110	1710	510	2310
6000	2000	2790	3435	635	1155	1675	2195	635	2195	1415	1155	1675	1155	1675	635	2195
8000	2000	3490	4025	625	1385	2145	2905	625	2905	1615	1385	2145	1385	2145	625	2905
10000	2000	4240	4690	625	1635	2645	3655	625	3655	2365	1635	2645	1635	2645	625	3655

R*: reversal quota

PUFFER

Size PFB

300 ≤ cap. ≤ 1.000

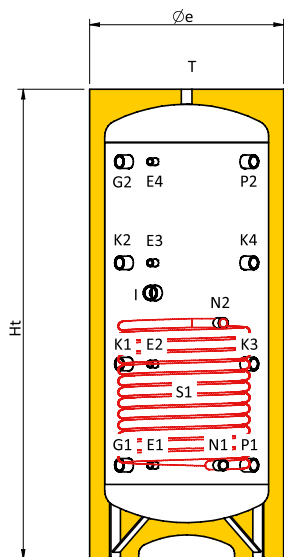

1.500 ≤ cap. ≤ 5.000

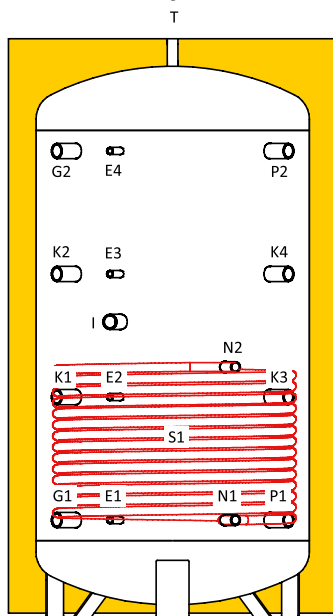

Couplings legend

E1	Probe / Thermometer
E2	Probe / Thermometer
E3	Probe / Thermometer
E4	Probe / Thermometer
G1	Ingresso da impianto
G2	To plant
I	Electrical resistor
K1	Auxiliary
K2	Auxiliary
K3	Auxiliary
K4	Auxiliary
N1	Lower exchanger outlet
N2	Lower exchanger inlet
P1	To energy source
P2	Ingresso da fonte energetica
S1	From energy source
T	Vent

Couplings chart

Cap. l	E1 inch	E2 inch	E3 inch	E4 inch	G1 inch	G2 inch	I inch	K1 inch	K2 inch	K3 inch	K4 inch	N1 inch	N2 inch	P1 inch	P2 inch	T inch
300	1/2"	1/2"	1/2"	1/2"	1 1/4	1 1/4	1 1/2	1 1/4	1 1/4	1 1/4	1 1/4	1"	1"	1 1/4	1 1/4	1 1/4
500	1/2"	1/2"	1/2"	1/2"	1 1/4	1 1/4	1 1/2	1 1/4	1 1/4	1 1/4	1 1/4	1"	1"	1 1/4	1 1/4	1 1/4
750	1/2"	1/2"	1/2"	1/2"	1 1/2	1 1/2	1 1/2	1 1/2	1 1/2	1 1/2	1 1/2	1"	1"	1 1/2	1 1/2	1 1/2
1000	1/2"	1/2"	1/2"	1/2"	1 1/2	1 1/2	1 1/2	1 1/2	1 1/2	1 1/2	1 1/2	1"	1"	1 1/2	1 1/2	1 1/2
1500	1/2"	1/2"	1/2"	1/2"	1 1/2	1 1/2	1 1/2	1 1/2	1 1/2	1 1/2	1 1/2	1"	1"	1 1/2	1 1/2	1"
2000	1/2"	1/2"	1/2"	1/2"	1 1/2	1 1/2	1 1/2	1 1/2	1 1/2	1 1/2	1 1/2	1"	1"	1 1/2	1 1/2	1"
2500	1/2"	1/2"	1/2"	1/2"	2"	2"	1 1/2	2"	2"	2"	2"	1"	1"	2"	2"	1"
3000	1/2"	1/2"	1/2"	1/2"	2"	2"	1 1/2	2"	2"	2"	2"	1"	1"	2"	2"	1"
4000	1/2"	1/2"	1/2"	1/2"	2"	2"	1 1/2	2"	2"	2"	2"	1"	1"	2"	2"	1"
5000	1/2"	1/2"	1/2"	1/2"	2"	2"	1 1/2	2"	2"	2"	2"	1"	1"	2"	2"	1"

Size chart

Cap. l	Øe mm	Ht mm	R* mm	E1 mm	E2 mm	E3 mm	E4 mm	G1 mm	G2 mm	I mm	K1 mm	K2 mm	K3 mm	K4 mm	N1 mm	N2 mm	P1 mm	P2 mm	S1 m ²
300	610	1680	1790	325	695	1065	1435	325	1435	880	695	1065	695	1065	325	685	325	1435	1
500	760	1735	1895	355	725	1095	1465	355	1465	985	725	1095	725	1095	355	875	355	1465	1.9
750	910	1765	1990	395	745	1095	1445	395	1445	920	745	1095	745	1095	395	875	395	1445	2.5
1000	1010	2000	2245	330	770	1210	1650	330	1650	990	770	1210	770	1210	330	890	330	1650	3.1
1500	1250	2145	2475	360	810	1260	1710	360	1710	1085	810	1260	810	1260	360	920	360	1710	3.8
2000	1350	2475	2815	390	930	1470	2010	390	2010	1200	930	1470	930	1470	390	990	390	2010	4.6
2500	1450	2220	2655	425	865	1305	1745	425	1745	1145	865	1305	865	1305	425	985	425	1745	5
3000	1450	2720	3085	435	1035	1635	2235	435	2235	1435	1035	1635	1035	1635	435	1115	435	2235	6
4000	1600	2810	3235	480	1080	1680	2280	480	2280	1430	1080	1680	1080	1680	480	1160	480	2280	7
5000	1800	2870	3390	510	1110	1710	2310	510	2310	1510	1110	1710	1110	1710	510	1190	510	2310	8

R*: reversal quota

PUFFER Size PFC

300 ≤ cap. ≤ 1.000

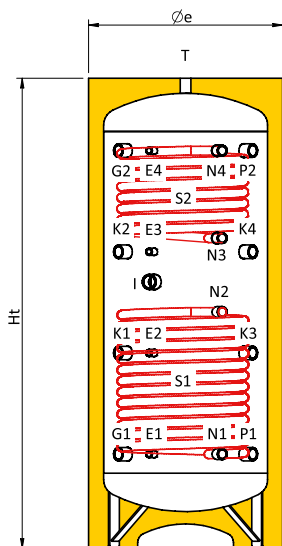

1.500 ≤ cap. ≤ 5.000

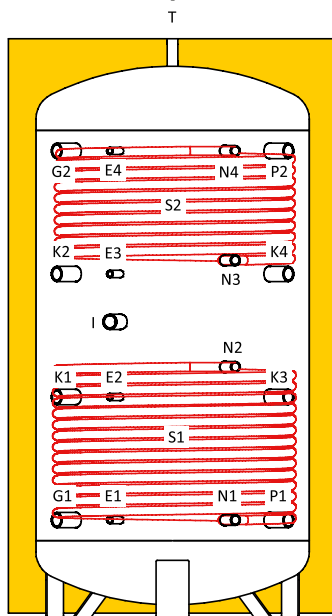

Couplings legend

E1	Probe / Thermometer
E2	Probe / Thermometer
E3	Probe / Thermometer
E4	Probe / Thermometer
G1	From plant
G2	To plant
I	Electrical resistor
K1	Auxiliary
K2	Auxiliary
K3	Auxiliary
K4	Auxiliary
N1	Lower exchanger outlet
N2	Lower exchanger inlet
N3	Upper exchanger outlet
N4	Upper exchanger inlet
P1	To energy source
P2	From energy source
S1	Lower exchanger
S2	Upper exchanger
T	Vent

Couplings chart

Cap. l	E1 inch	E2 inch	E3 inch	E4 inch	G1 inch	G2 inch	I inch	K1 inch	K2 inch	K3 inch	K4 inch	N1 inch	N2 inch	N3 inch	N4 inch	P1 inch	P2 inch	T inch
300	1/2"	1/2"	1/2"	1/2"	1 1/4	1 1/4	1 1/2	1 1/4	1 1/4	1 1/4	1 1/4	1'	1'	1'	1'	1 1/4	1 1/4	1 1/4
500	1/2"	1/2"	1/2"	1/2"	1 1/4	1 1/4	1 1/2	1 1/4	1 1/4	1 1/4	1 1/4	1'	1'	1'	1'	1 1/4	1 1/4	1 1/4
750	1/2"	1/2"	1/2"	1/2"	1 1/2	1 1/2	1 1/2	1 1/2	1 1/2	1 1/2	1 1/2	1'	1'	1'	1'	1 1/2	1 1/2	1 1/2
1000	1/2"	1/2"	1/2"	1/2"	1 1/2	1 1/2	1 1/2	1 1/2	1 1/2	1 1/2	1 1/2	1'	1'	1'	1'	1 1/2	1 1/2	1 1/2
1500	1/2"	1/2"	1/2"	1/2"	1 1/2	1 1/2	1 1/2	1 1/2	1 1/2	1 1/2	1 1/2	1'	1'	1'	1'	1 1/2	1 1/2	1'
2000	1/2"	1/2"	1/2"	1/2"	1 1/2	1 1/2	1 1/2	1 1/2	1 1/2	1 1/2	1 1/2	1'	1'	1'	1'	1 1/2	1 1/2	1'
2500	1/2"	1/2"	1/2"	1/2"	2"	2"	1 1/2	2"	2"	2"	2"	1'	1'	1'	1'	2"	2"	1'
3000	1/2"	1/2"	1/2"	1/2"	2"	2"	1 1/2	2"	2"	2"	2"	1'	1'	1'	1'	2"	2"	1'
4000	1/2"	1/2"	1/2"	1/2"	2"	2"	1 1/2	2"	2"	2"	2"	1'	1'	1'	1'	2"	2"	1'
5000	1/2"	1/2"	1/2"	1/2"	2"	2"	1 1/2	2"	2"	2"	2"	1'	1'	1'	1'	2"	2"	1'

Size chart

Cap. l	Øe mm	Ht mm	R* mm	E1 mm	E2 mm	E3 mm	E4 mm	G1 mm	G2 mm	I mm	K1 mm	K2 mm	K3 mm	K4 mm	N1 mm	N2 mm	N3 mm	N4 mm	P1 mm	P2 mm	S1 m²	S2 m²
300	610	1680	1790	325	695	1065	1435	325	1435	880	695	1065	695	1065	325	685	685	1075	325	1435	1	1
500	760	1735	1895	355	725	1095	1465	355	1465	985	725	1095	725	1095	355	875	875	1145	355	1465	1.9	1.2
750	910	1765	1990	395	745	1095	1445	395	1445	920	745	1095	745	1095	395	875	875	1210	395	1445	2.5	1.5
1000	1010	2000	2245	330	770	1210	1650	330	1650	990	770	1210	770	1210	330	890	1210	1650	330	1650	3.1	2.5
1500	1240	2140	2475	360	810	1260	1710	360	1710	1085	810	1260	810	1260	360	920	920	1310	360	1710	3.8	2.8
2000	1340	2470	2815	390	930	1470	2010	390	2010	1200	930	1470	930	1470	390	990	990	1650	390	2010	4.6	2.8
2500	1450	2220	2655	425	865	1305	1745	425	1745	1145	865	1305	865	1305	425	985	985	1305	425	1745	5	4
3000	1450	2720	3085	435	1035	1635	2235	435	2235	1435	1035	1635	1035	1635	435	1115	1115	1755	435	2235	6	4.2
4000	1600	2810	3235	480	1080	1680	2280	480	2280	1430	1080	1680	1080	1680	480	1160	1160	1800	480	2280	7	5
5000	1800	2870	3390	510	1110	1710	2310	510	2310	1510	1110	1710	1110	1710	510	1190	1190	1910	510	2310	8	5

R*: reversal quota

PUFFER

Installation chart

List of components

- 1 PFC Fiorini Puffer
- 2 Safety unit
- 3 Heating by alternative source
- 4 solar thermal return unit
- 5 bacteriostatic cold water filter
- 6 Heating circuit 1
- 7 Heating circuit 2
- 8 Fiorini solar collectors
- 9 Heater or stove with open vessel

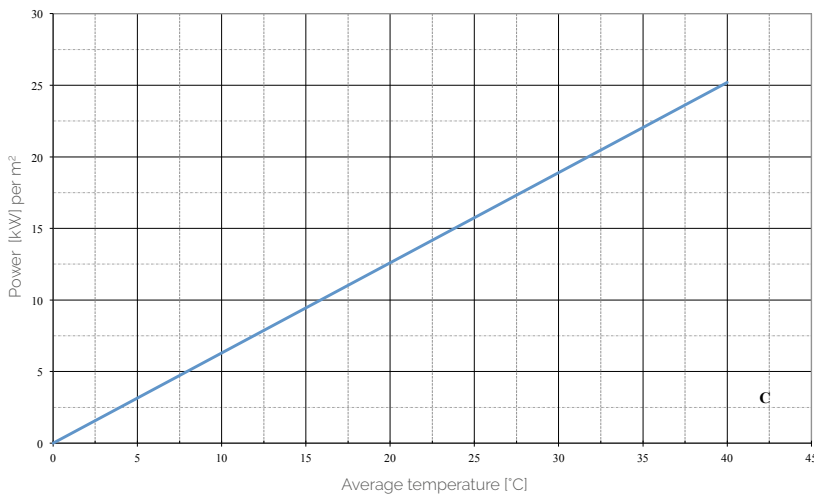
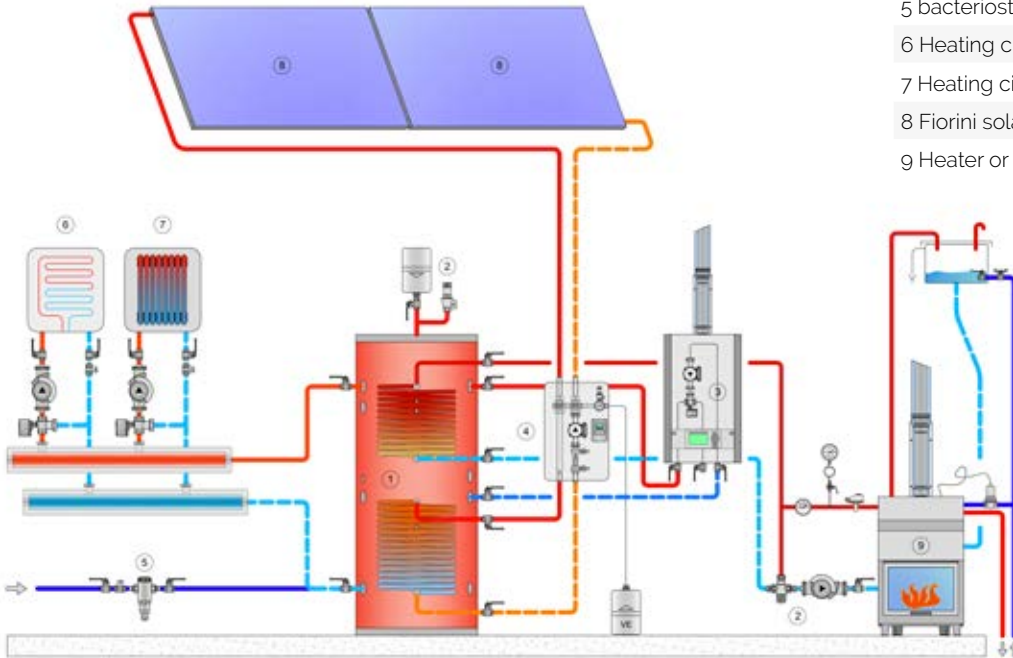

Fixed coil power

The chart indicates maximum exchanged power by the fix internal coil depending on the temperature difference between water into the coil and water into the tank.

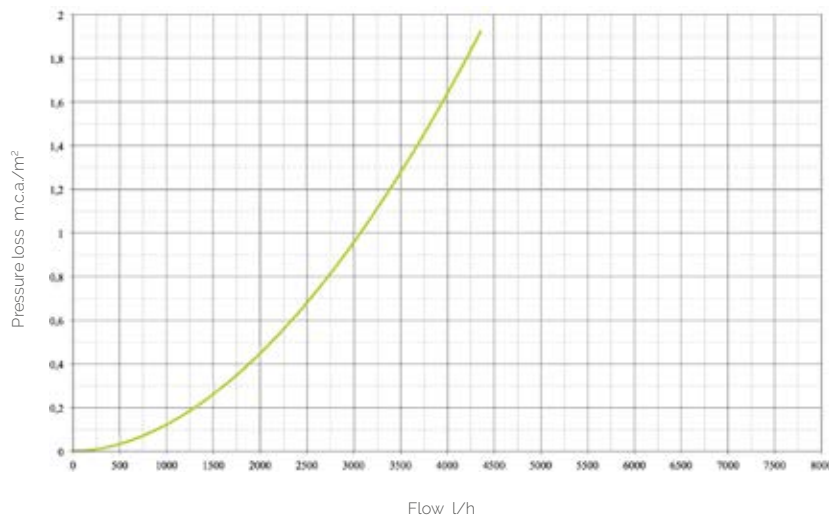

Pressure loss in the fixed coil

The pressure loss indicated in the chart refers to a surface area of 1 m² of the coil. Multiply this value with the exchange surface in order to come to the total pressure loss.

COMBI PLUS

Combi storage tank

The COMBI PLUS range consists of inertial tanks for installations which use discontinuous energy sources, such as solar power systems, biomass systems and wood burning systems. Thanks to the internal exchanger with a stainless steel corrugated tube with a large surface, the instantaneous DHW production is guaranteed. There are three versions of which several capacities are available, from 600 to 2000 litres.

COMBI PLUS A: equipped with n°1 internal fixed exchanger with a stainless steel corrugated tube for instantaneous DHW production

COMBI PLUS B: equipped with n°2 internal fixed heat exchangers, one with a stainless steel corrugated tube for instantaneous DHW production and another for coupling to an additional heat source.

COMBI PLUS C: equipped with n°3 internal fixed heat exchangers, one with a stainless steel corrugated tube for instantaneous DHW production and two in carbon steel for coupling to other additional heat sources

Materials

The inertial tanks are made of high quality material, in particular:

Coil for domestic use: AISI 316L stainless steel

Tank and integration coil: S 235 JR carbon steel

External protective treatment: enamelling with industrial varnish

Insulation

Capacity (l)	Type
from 600 to 2000	Polystyrene Graphite + Polyester Fiber

Operational limits

Storage tank		S1 Coil Circuit		S2-S3 Coil Circuit	
max. temperature	max. pressure	max. temperature	max. pressure	max. temperature	max. pressure
90°C	3 bar	90°C	6 bar	90°C	16 bar

 **Supplied accessories:** Adjustable height feet for sizes up to 500 l, safety valve and thermometer for sizes up to 1000 l, magnesium sacrificial anode for all sizes.

 **Standard accessories:** see pag 274

 **Special versions:** see pag 277

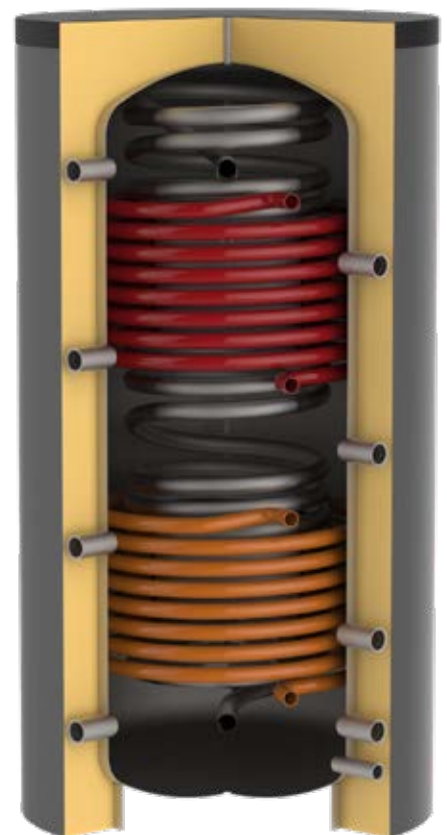



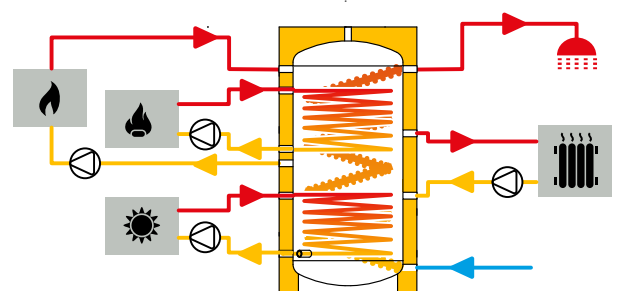

TESTED







COMBI PLUS

Combi storage tank





COMBI PLUS A

capacity l	code	price	energy label	packed	
				dimensions cm	weight kg
600	842020178X	€ 2.828,00		97x97x205	195
750	842020179X	€ 3.030,00		105x105x203	210
1000	842020180X	€ 3.263,00		105x105x242	238
1500	842020181X	€ 4.273,00		115x115x283	330
2000	842020182X	€ 5.353,00		135x135x265	378

COMBI PLUS B

capacity l	code	price	energy label	packed	
				dimensions cm	weight kg
600	842020148X	€ 2.980,00		97x97x205	205
750	842020149X	€ 3.293,00		105x105x203	232
1000	842020150X	€ 3.535,00		105x105x242	246
1500	842020151X	€ 4.545,00		115x115x283	371
2000	842020152X	€ 5.606,00		135x135x265	404

COMBI PLUS C

capacity l	code	price	energy label	packed	
				dimensions cm	weight kg
600	842020153X	€ 3.232,00		97x97x205	220
750	842020154X	€ 3.535,00		105x105x203	254
1000	842020155X	€ 3.788,00		105x105x242	278
1500	842020156X	€ 4.798,00		115x115x283	411
2000	842020157X	€ 5.909,00		135x135x265	455

COMBI PLUS A

Dimensions

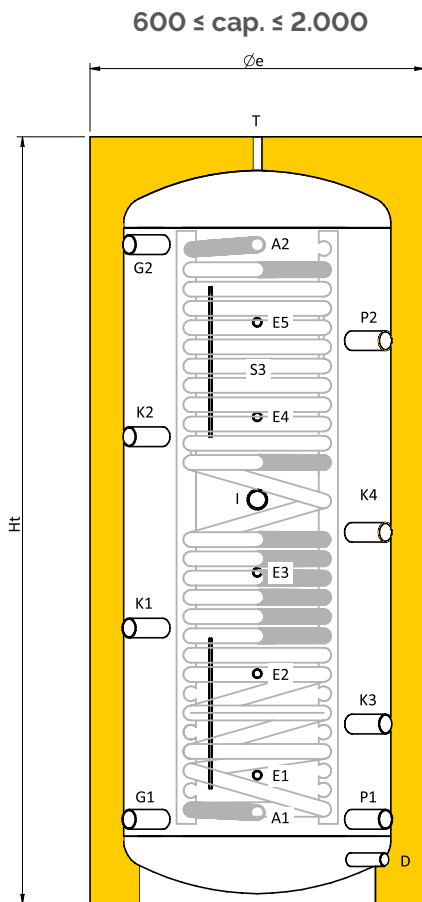

Couplings legend

A1	DHW inlet
A2	DHW outlet
D	Drain
E1	Probe / Thermometer
E2	Probe / Thermometer
E3	Probe / Thermometer
E4	Probe / Thermometer
E5	Probe / Thermometer
G1	From plant
G2	To plant
I	Electrical resistor
K1	Auxiliary
K2	Auxiliary
K3	Auxiliary
K4	Auxiliary
P1	To energy source
P2	From energy source
S3	DHW exchanger
T	Vent

Couplings chart

Cap. l	A1 inch	A2 inch	D inch	E1 inch	E2 inch	E3 inch	E4 inch	E5 inch	G1 inch	G2 inch	I inch	K1 inch	K2 inch	K3 inch	K4 inch	P1 inch	P2 inch	T inch
600	1 1/4	1 1/4	1	1/2	1/2	1/2	1/2	1/2	1 1/2	1 1/2	1 1/2	1 1/2	1 1/2	1 1/2	1 1/2	1 1/2	1 1/2	1 1/2
750	1 1/4	1 1/4	1	1/2	1/2	1/2	1/2	1/2	1 1/2	1 1/2	1 1/2	1 1/2	1 1/2	1 1/2	1 1/2	1 1/2	1 1/2	1 1/2
1000	1 1/4	1 1/4	1	1/2	1/2	1/2	1/2	1/2	1 1/2	1 1/2	1 1/2	1 1/2	1 1/2	1 1/2	1 1/2	1 1/2	1 1/2	1 1/2
1500	1 1/4	1 1/4	1	1/2	1/2	1/2	1/2	1/2	1 1/2	1 1/2	1 1/2	1 1/2	1 1/2	1 1/2	1 1/2	1 1/2	1 1/2	1 1/2
2000	1 1/4	1 1/4	1	1/2	1/2	1/2	1/2	1/2	1 1/2	1 1/2	1 1/2	1 1/2	1 1/2	1 1/2	1 1/2	1 1/2	1 1/2	1 1/2

Size chart

Cap. l	Øe mm	Ht mm	R* mm	A1 mm	A2 mm	E1 mm	E2 mm	E3 mm	E4 mm	E5 mm	G1 mm	G2 mm	I mm	K1 mm	K2 mm	K3 mm	K4 mm	P1 mm	P2 mm	S3 m ²
600	860	1930	2115	270	1560	420	643	865	1215	1410	275	1555	1030	701	1129	488	915	275	1342	5.65
750	950	1900	2125	285	1570	395	585	765	1165	1420	265	1565	950	698	1132	482	915	265	1348	5.65
1000	950	2305	2495	285	1965	395	695	995	1440	1735	265	1965	1220	831	1397	548	1114	265	1681	6.95
1500	1100	2665	2885	400	2260	510	875	1240	1680	2020	380	2260	1440	1015	1640	705	1325	380	1950	6.95
2000	1300	2475	2800	380	2030	610	840	1070	1530	1830	380	2030	1310	925	1475	655	1205	380	1750	8

R*: reversal quota

COMBI PLUS B

Dimensions

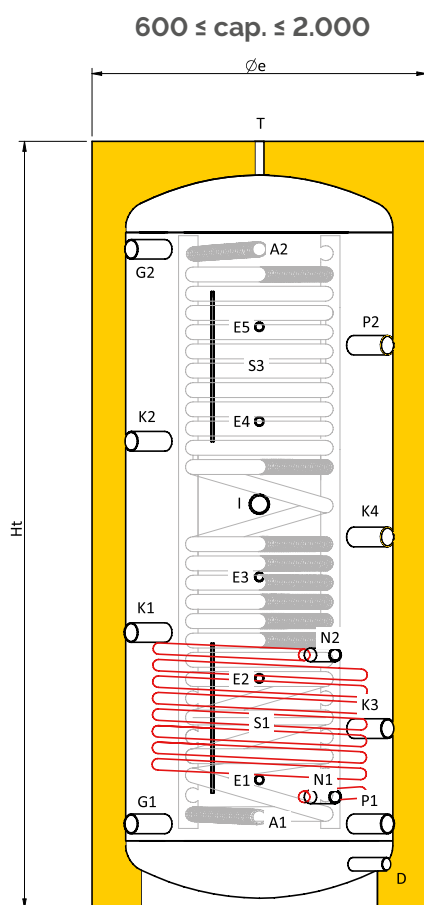

Couplings legend

A1	DHW inlet
A2	DHW outlet
D	Drain
E1	Probe / Thermometer
E2	Probe / Thermometer
E3	Probe / Thermometer
E4	Probe / Thermometer
E5	Probe / Thermometer
G1	From plant
G2	To plant
I	Electrical resistor
K1	Auxiliary
K2	Auxiliary
K3	Auxiliary
K4	Auxiliary
N1	Lower exchanger outlet
N2	Lower exchanger inlet
P1	To energy source
P2	From energy source
S1	Lower exchanger
S3	DHW exchanger
T	Vent

Couplings chart

Cap. l	A1 inch	A2 inch	D inch	E1 inch	E2 inch	E3 inch	E4 inch	E5 inch	G1 inch	G2 inch	I inch	K1 inch	K2 inch	K3 inch	K4 inch	N1 inch	N2 inch	P1 inch	P2 inch	T inch
600	1 1/4	1 1/4	1	1/2	1/2	1/2	1/2	1/2	1 1/2	1 1/2	1 1/2	1 1/2	1 1/2	1 1/2	1 1/2	1	1	1 1/2	1 1/2	1/2
750	1 1/4	1 1/4	1	1/2	1/2	1/2	1/2	1/2	1 1/2	1 1/2	1 1/2	1 1/2	1 1/2	1 1/2	1 1/2	1	1	1 1/2	1 1/2	1/2
1000	1 1/4	1 1/4	1	1/2	1/2	1/2	1/2	1/2	1 1/2	1 1/2	1 1/2	1 1/2	1 1/2	1 1/2	1 1/2	1	1	1 1/2	1 1/2	1/2
1500	1 1/4	1 1/4	1	1/2	1/2	1/2	1/2	1/2	1 1/2	1 1/2	1 1/2	1 1/2	1 1/2	1 1/2	1 1/2	1	1	1 1/2	1 1/2	1/2
2000	1 1/4	1 1/4	1	1/2	1/2	1/2	1/2	1/2	1 1/2	1 1/2	1 1/2	1 1/2	1 1/2	1 1/2	1 1/2	1	1	1 1/2	1 1/2	1/2

Size chart

Cap. l	Øe mm	Ht mm	R' mm	A1 mm	A2 mm	E1 mm	E2 mm	E3 mm	E4 mm	E5 mm	G1 mm	G2 mm	I mm	K1 mm	K2 mm	K3 mm	K4 mm	N1 mm	N2 mm	P1 mm	P2 mm	S1 m ²	S3 m ²
600	860	1930	2115	270	1560	420	643	865	1215	1410	275	1555	1030	701	1129	488	915	345	745	275	1342	1,4	5,65
750	950	1900	2125	285	1570	395	585	765	1165	1420	265	1565	950	698	1132	482	915	345	765	265	1348	1,8	5,65
1000	950	2305	2495	285	1965	395	695	995	1440	1735	265	1965	1220	831	1397	548	1114	345	765	265	1681	1,8	6,95
1500	1100	2665	2885	400	2260	510	875	1240	1680	2020	380	2260	1440	1015	1640	705	1325	460	1260	380	1950	3	6,95
2000	1300	2475	2800	380	2030	610	840	1070	1530	1830	380	2030	1310	925	1475	655	1205	450	1250	380	1750	4,5	8

R': reversal quota

COMBI PLUS C

Dimensions

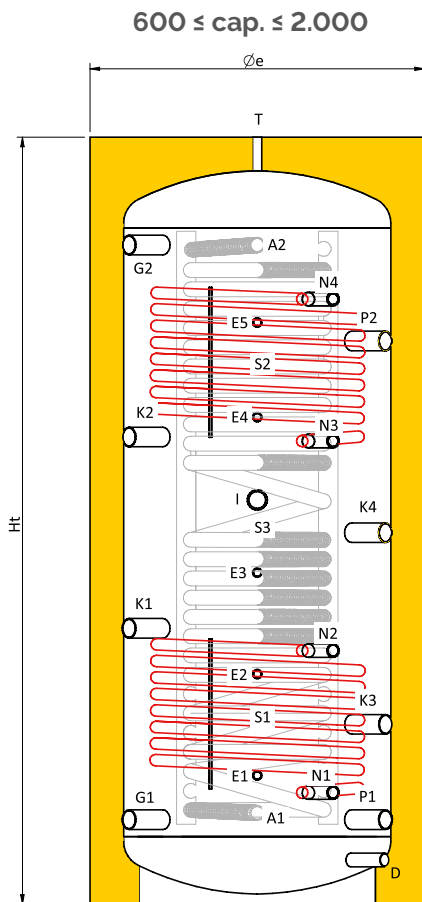

Couplings legend

A1	DHW inlet
A2	DHW outlet
D	Drain
E1	Probe / Thermometer
E2	Probe / Thermometer
E3	Probe / Thermometer
E4	Probe / Thermometer
E5	Probe / Thermometer
G1	From plant
G2	To plant
I	Electrical resistor
K1	Auxiliary
K2	Auxiliary
K3	Auxiliary
K4	Auxiliary
N1	Lower exchanger outlet
N2	Lower exchanger inlet
N3	Upper exchanger outlet
N4	Upper exchanger inlet
P1	To energy source
P2	From energy source
S1	Lower exchanger
S2	Upper exchanger
S3	DHW exchanger
T	Vent

Couplings chart

Cap. l	A1 inch	A2 inch	D inch	E1 inch	E2 inch	E3 inch	E4 inch	E5 inch	G1 inch	G2 inch	I inch	K1 inch	K2 inch	K3 inch	K4 inch	N1 inch	N2 inch	N3 inch	N4 inch	P1 inch	P2 inch	T inch
600	1 1/4	1 1/4	1	1/2	1/2	1/2	1/2	1/2	1 1/2	1 1/2	1 1/2	1 1/2	1 1/2	1 1/2	1 1/2	1	1	1	1	1 1/2	1 1/2	1/2
750	1 1/4	1 1/4	1	1/2	1/2	1/2	1/2	1/2	1 1/2	1 1/2	1 1/2	1 1/2	1 1/2	1 1/2	1 1/2	1	1	1	1	1 1/2	1 1/2	1/2
1000	1 1/4	1 1/4	1	1/2	1/2	1/2	1/2	1/2	1 1/2	1 1/2	1 1/2	1 1/2	1 1/2	1 1/2	1 1/2	1	1	1	1	1 1/2	1 1/2	1/2
1500	1 1/4	1 1/4	1	1/2	1/2	1/2	1/2	1/2	1 1/2	1 1/2	1 1/2	1 1/2	1 1/2	1 1/2	1 1/2	1	1	1	1	1 1/2	1 1/2	1/2
2000	1 1/4	1 1/4	1	1/2	1/2	1/2	1/2	1/2	1 1/2	1 1/2	1 1/2	1 1/2	1 1/2	1 1/2	1 1/2	1	1	1	1	1 1/2	1 1/2	1/2

Size chart

Cap. l	∅e mm	Ht mm	R' mm	A1 mm	A2 mm	E1 mm	E2 mm	E3 mm	E4 mm	E5 mm	G1 mm	G2 mm	I mm	K1 mm	K2 mm	K3 mm	K4 mm	N1 mm	N2 mm	N3 mm	N4 mm	P1 mm	P2 mm	S1 m ²	S2 m ²	S3 m ²
600	860	1930	2115	270	1560	420	643	865	1215	1410	275	1555	1030	701	1129	488	915	345	745	1105	1505	275	1342	1.4	1.4	5.65
750	950	1900	2125	285	1570	395	585	765	1165	1420	265	1565	950	698	1132	482	915	345	765	1075	1495	265	1348	1.8	1.8	5.65
1000	950	2305	2495	285	1965	395	695	995	1440	1735	265	1965	1220	831	1397	548	1114	345	765	1385	1805	265	1681	1.8	1.8	6.95
1500	1100	2665	2885	400	2260	510	875	1240	1680	2020	380	2260	1440	1015	1640	705	1325	460	1260	1590	2190	380	1950	3	2.4	6.95
2000	1300	2475	2800	380	2030	610	840	1070	1530	1830	380	2030	1310	925	1475	655	1205	450	1250	1410	1960	380	1750	4.5	3	8

R': reversal quota

COMBI PLUS

Installation chart

List of components

- 1 PFC Fiorini Puffer
- 2 Safety unit
- 3 Heating by alternative source
- 4 solar thermal return unit
- 5 bacteriostatic cold water filter
- 6 Heating circuit 1
- 7 Heating circuit 2
- 8 Fiorini solar collectors
- 9 Heater or stove with open vessel

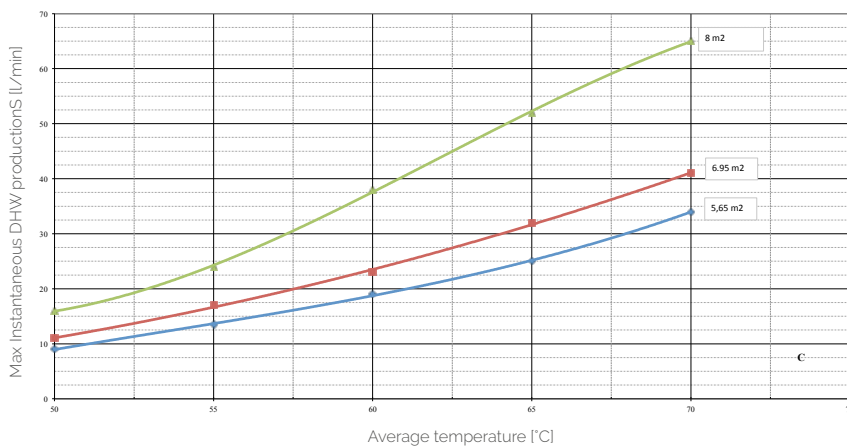
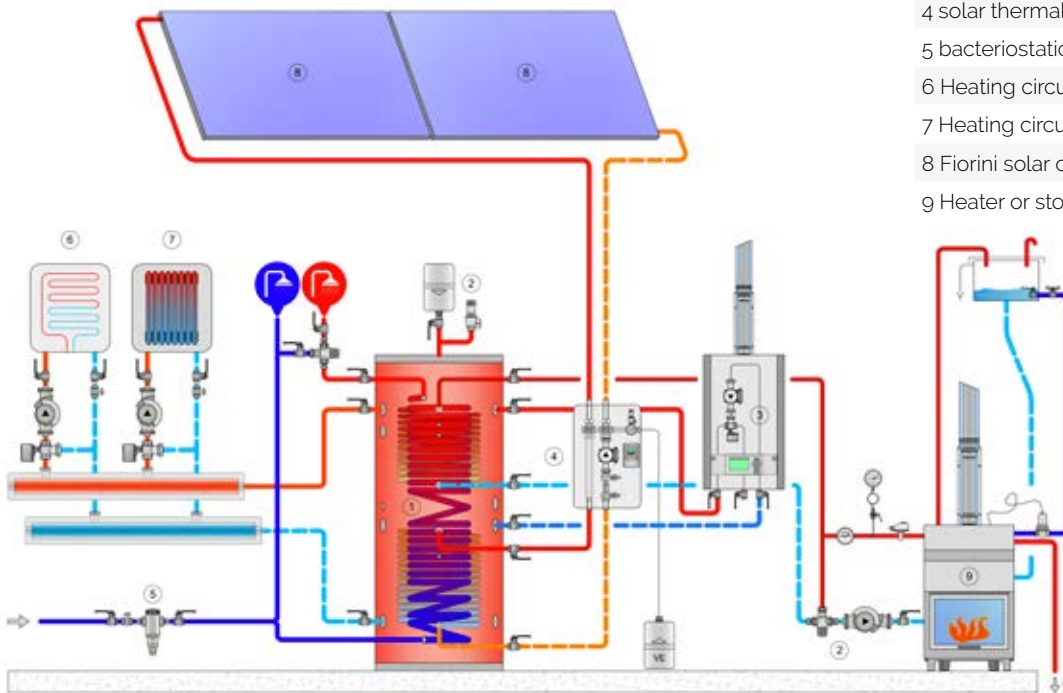

Instantaneous DHW production

The chart indicates the maximum instantaneous DHW production (10-45°C) through the stainless steel coil in function of the storage temperature in the tank

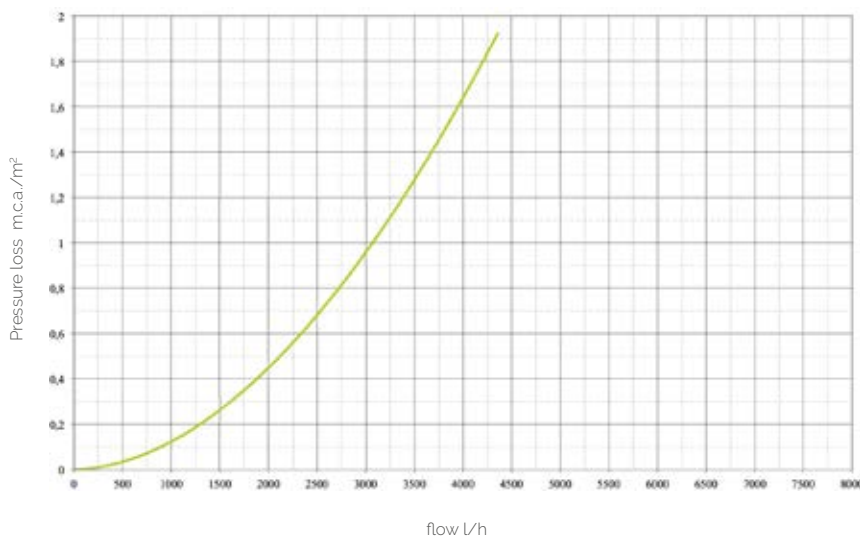

Pressure loss in the fixed coil

The pressure loss indicated in the chart refers to a surface area of 1 m² of the coil. Multiply this value with the exchange surface in order to come to the total pressure loss.



Download additional
content

 go.forinigroup.it/eng/content

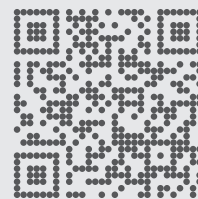

fiorini

Fiorini Industries S.r.l.
Ph. +39 0543 723197 – Fax +39 0543 720413
Via Zampeschi 119 – 47122 Forlì (FC) – Italy
www.fiorini-industries.com